

Morgan Lewis

TECHNOLOGY MARATHON

An Introduction to the Metaverse

Dion Bregman, Jason Gettleman, and Jeanette Kernizan Adelson

June 1 | 12:00-1:00 pm ET

Presenters



Dion M. Bregman
Partner
Silicon Valley, CA



Jason E. Gettleman
Partner
Silicon Valley, CA



Jeanette Kernizan Adelson
Law Clerk
New York, NY

Morgan Lewis

Agenda

- What is the Metaverse?
- How do non-fungible tokens (NFTs) and cryptocurrency relate to the Metaverse?
- Brief Metaverse tour
- IP and Corporate issues to consider in the Metaverse
- Where do we see the Metaverse headed in 5-10 years?

The Evolution of the Web



1990

Web 1.0

Information economy
Read
Search
Desktop Infrastructure
E-commerce

2005

Web 2.0

Storage
Web as a Platform
Collaborative
Social Media
SmartPhones
Apps
Corporations monopolized internet
Platforms own and manipulate data

2020

Web 3.0

Token Economy
Interactive
Decentralized
Users monetize their own data
3D graphics

Present



The Evolution of the Metaverse



Roblox
Online game platform

<https://nbcnews.com>

2000

2005

2020

Present

The Sims

Strategic life simulation video game

Second Life

Online multimedia platform that allows to create avatars in the virtual world

Decentraland

Decentralized metaverse

Morgan Lewis

<https://ea.com>



What is the Metaverse?

Generally, a “metaverse” is a term used to describe any virtual world where users can interact using digital avatars



Morgan Lewis

<https://instagram.com/sandboxHorizonWorld>

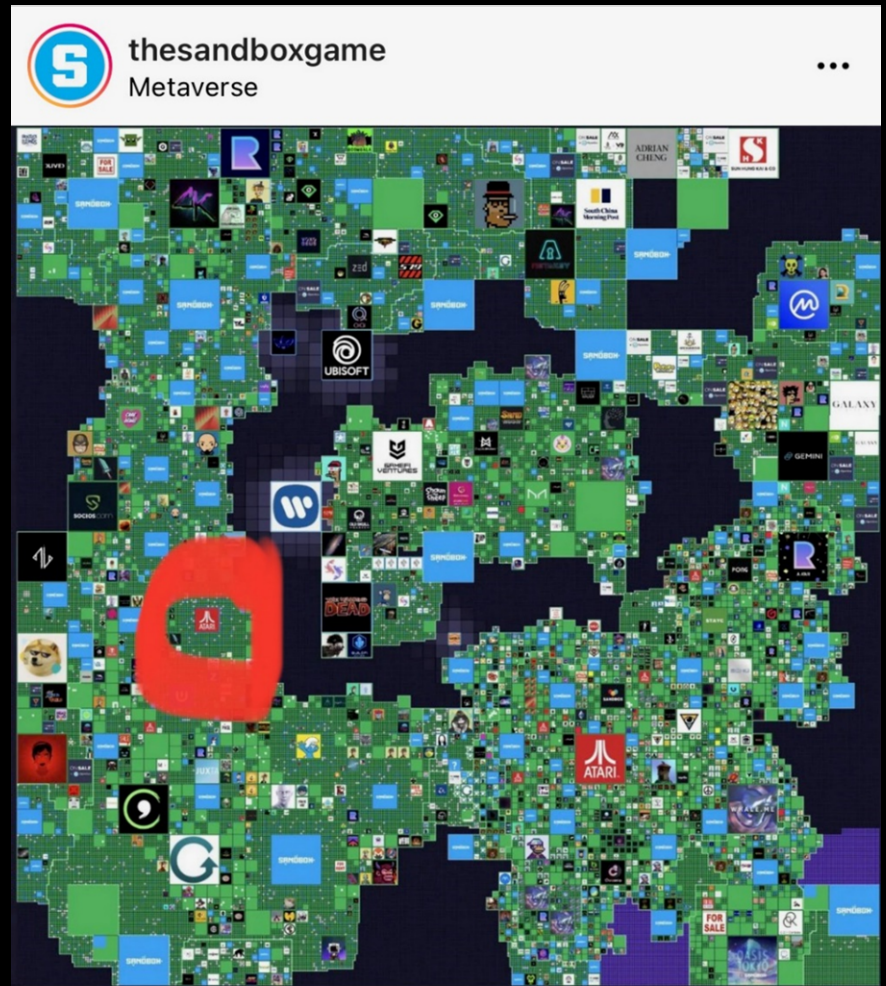

EXPLORING THE 7 LAYERS OF THE METAVERSE

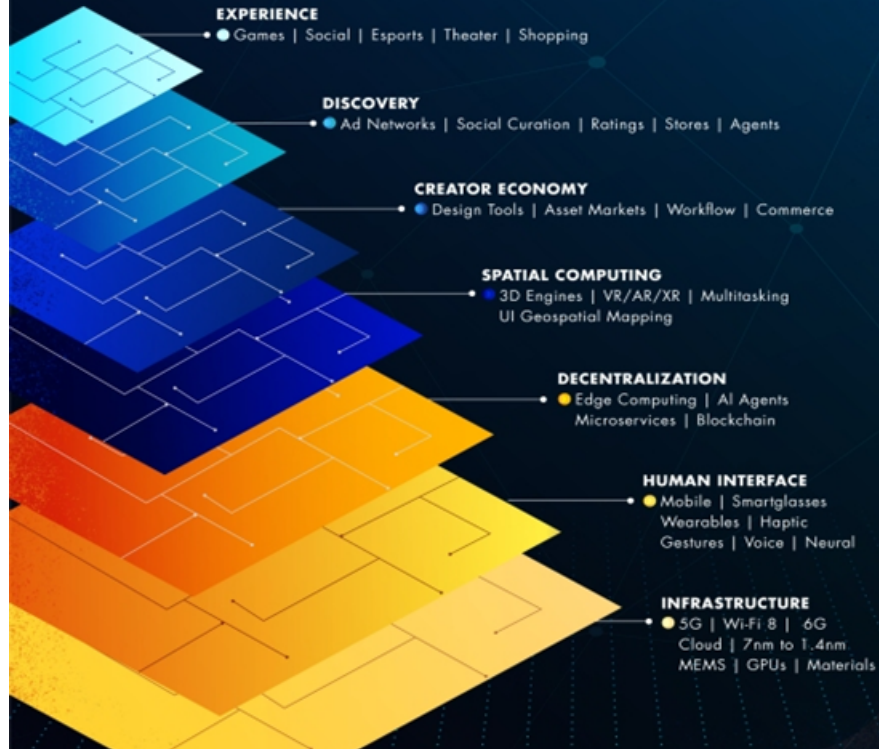

Elements of a Metaverse

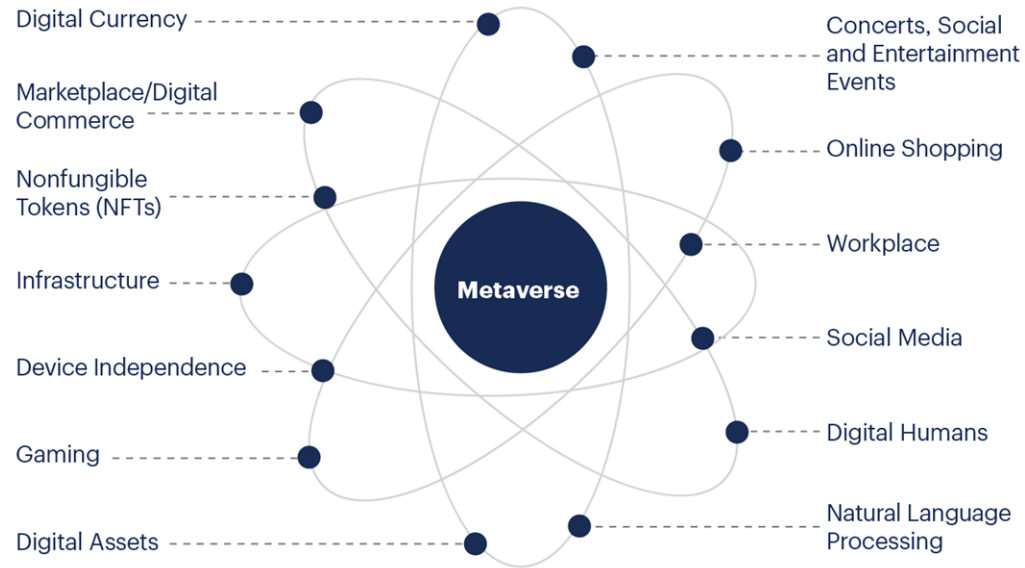

gartner.com

Source: Gartner
© 2022 Gartner, Inc. and/or its affiliates. All rights reserved. CTMKT_1635001

Gartner

Metaverse Gateways

	Centralized	Decentralized
Player-first content (UGC Rich)		
Dev-first content		

<https://d-core.net/en/>

Metaverse Growth Outlook

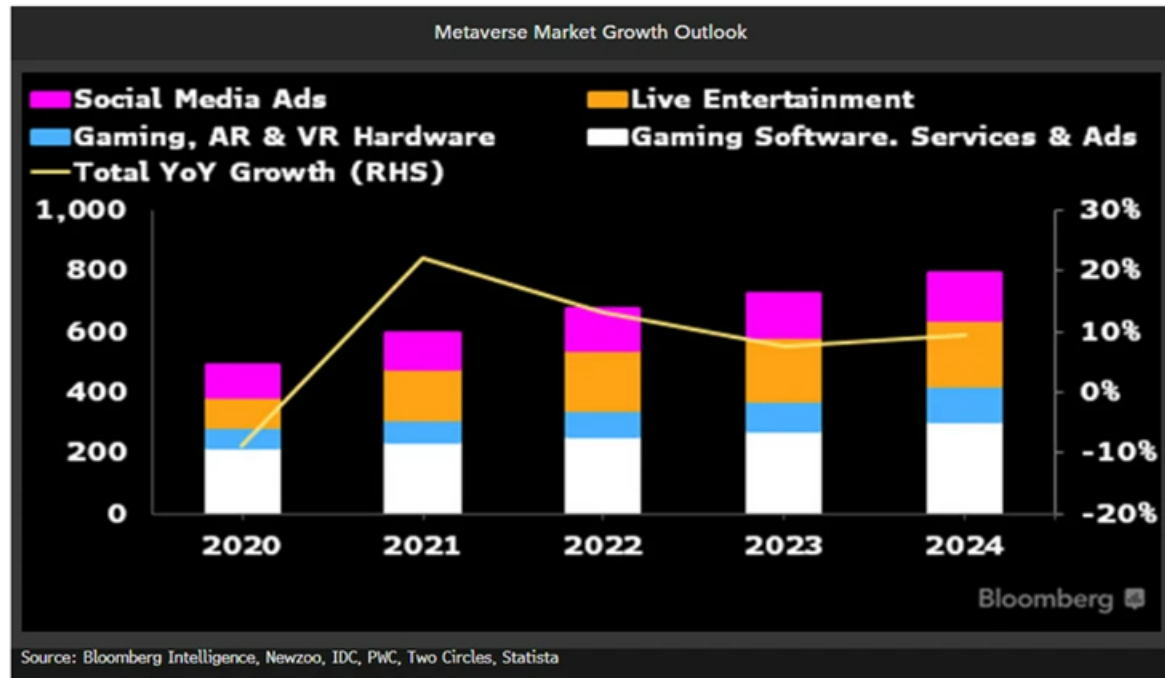

<https://www.bloomberg.com/professional/blog/metaverse-may-be-800-billion-market-next-tech-platform/>

How Do NFTs Impact The Metaverse?

Morgan Lewis

<https://opensea.io/>



NFT

NFT stands for non-fungible token. An NFT is a non-interchangeable unit of data stored on a block chain, a form of digital ledger. The NFT allows for authentic ownership.

In the metaverse, all things can be NFTs. The NFT can be décor in your virtual space. The NFT can be the very space itself. There is no limit on how to utilize NFTs in the metaverse.

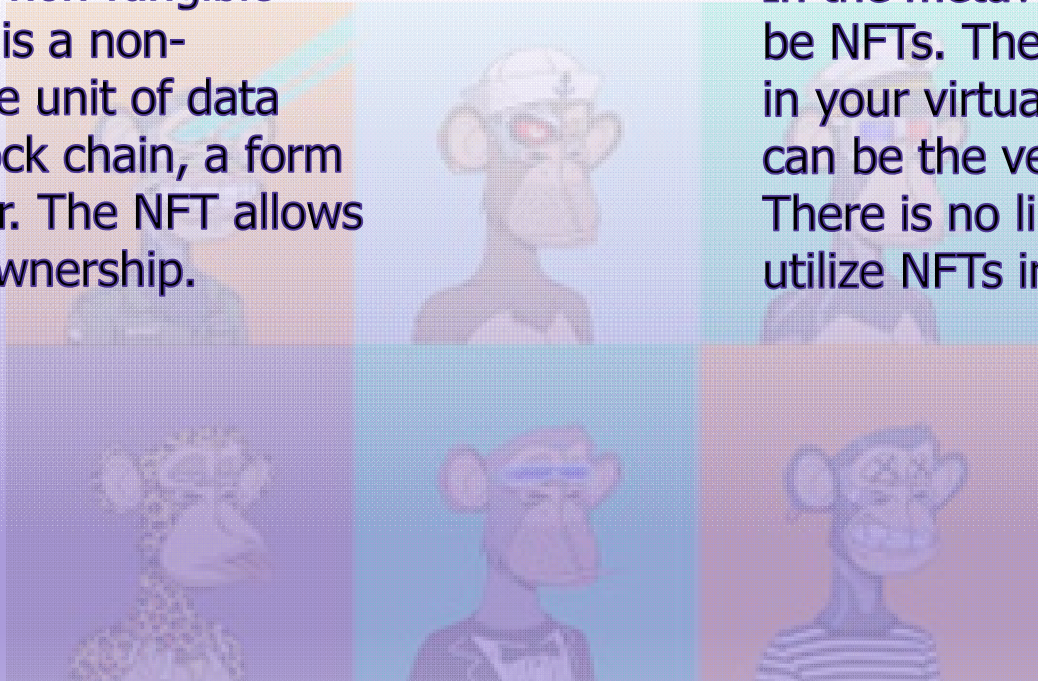



How Does Cryptocurrency Relate To The Metaverse?

Morgan Lewis

<https://opensea.io/>

Digital Wallets



<https://docs.decentraland.org/examples/get-a-wallet/>

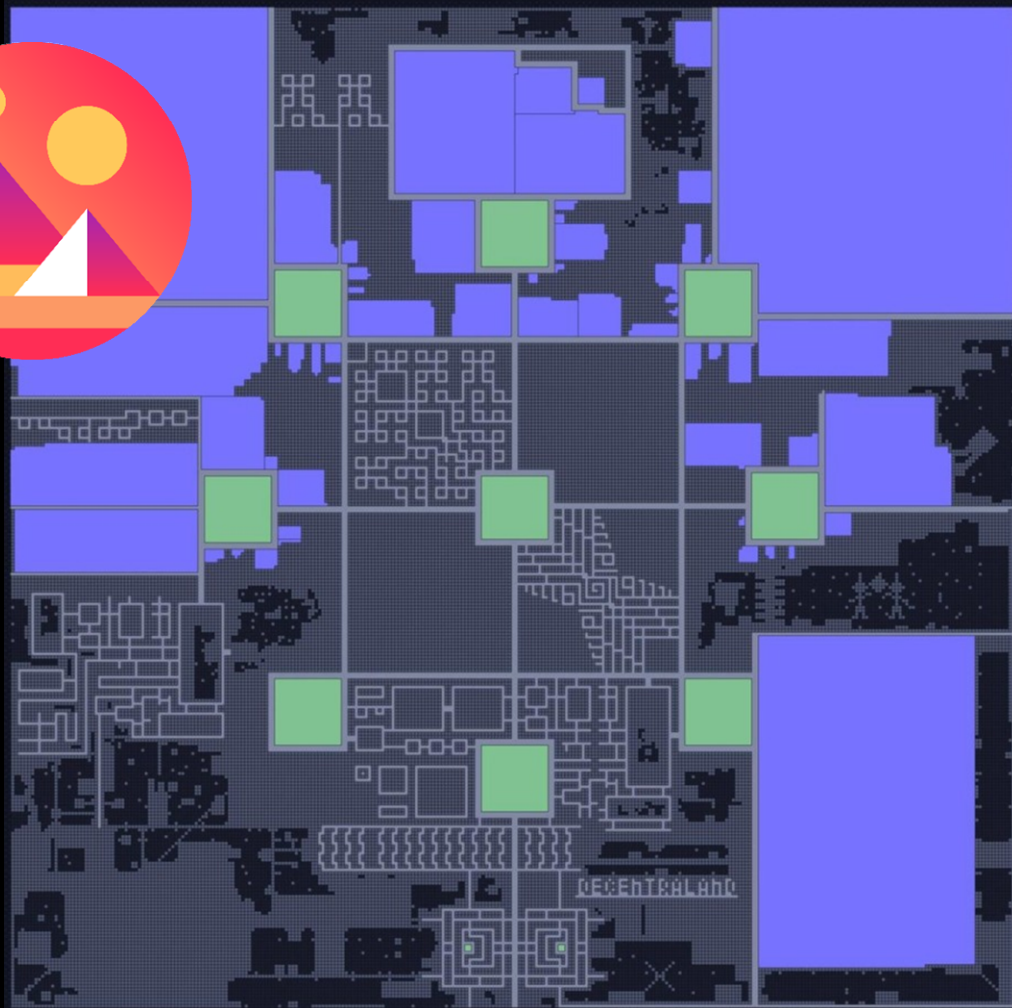



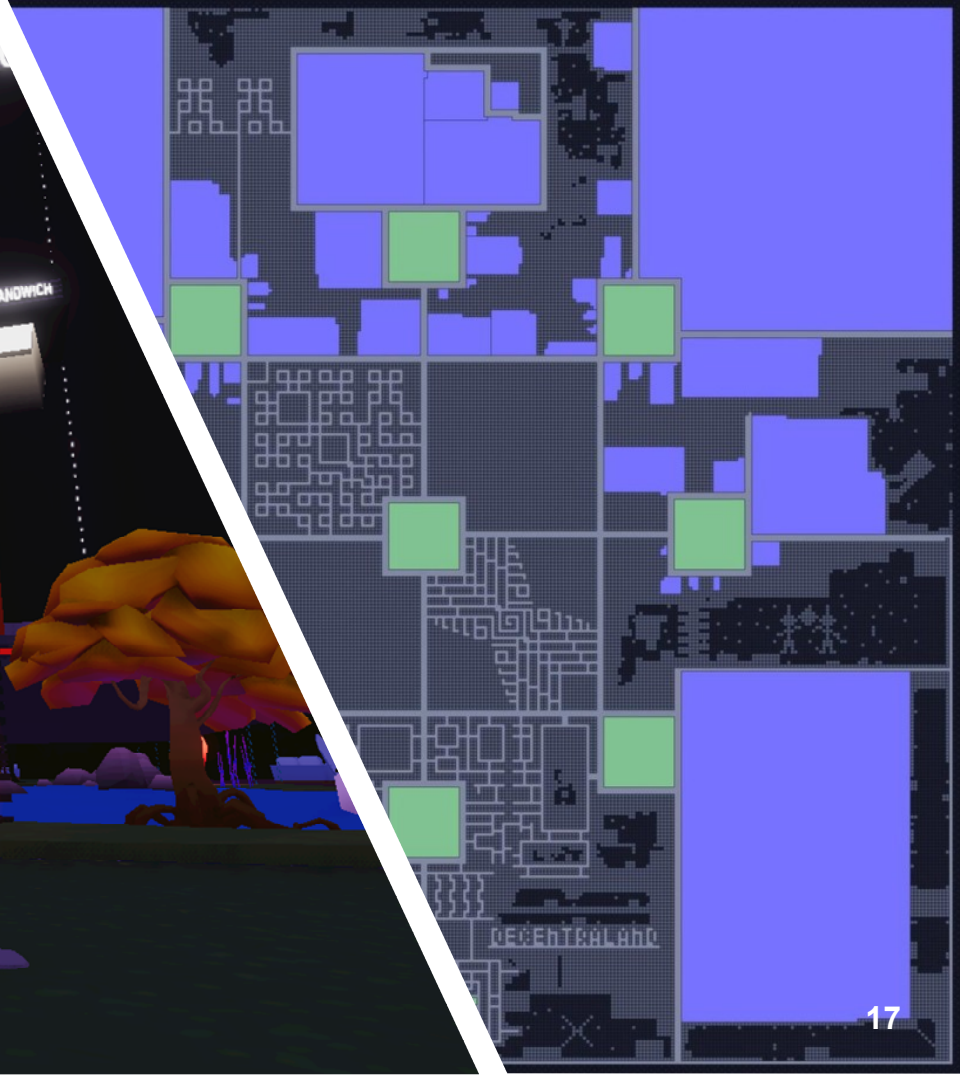

How to BUILD YOUR METASANDWICH



Step 1.
READ THIS SIGN

Step 2.
ACQUIRE BREAD
FROM GREETER BOT

Step 3.
OBTAIN INGREDIENTS
AROUND STORE
[LOOK FOR ]

Step 4.
SUBMIT YOUR
METASANDWICH BELOW

10110010 10010010 01010010
00000100 10010100 10101000
00010010 11100100 01010010
11001010 11001000 01100010

WE
IT'S

Submit Your
METASANDWICH

18
CLICK TO DROP ITEM



Would you like to add Lettuce to your Metasandwich?

Ok, health freak!

Cancel Add Lettuce

Right-Click to Interact

CLICK TO DROP ITEM



ANDY



That's a good looking Metasandwich.
Ready to submit it?

No

Yes

Right-Click to Interact



20

CLICK TO DROP ITEM

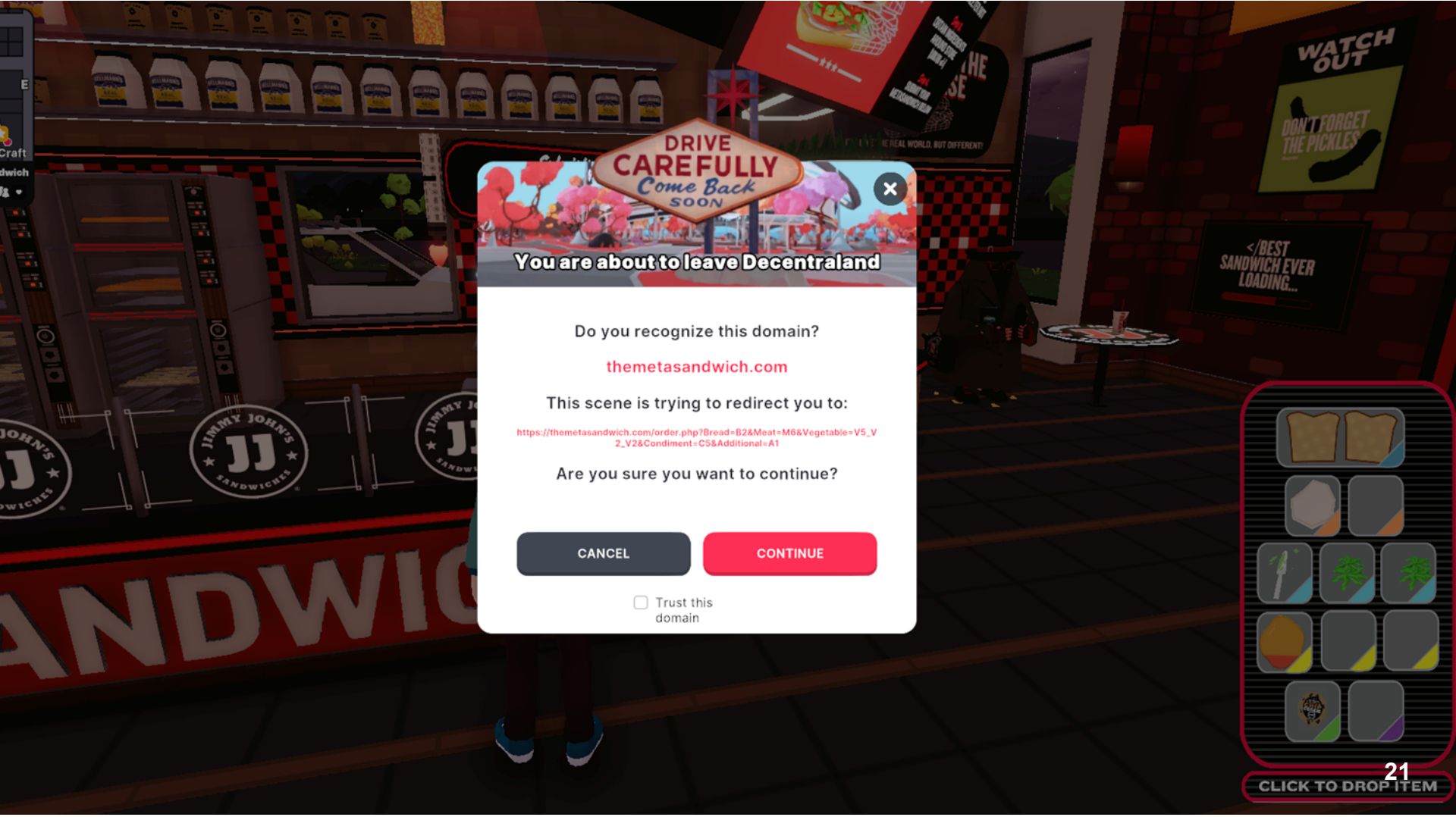

DRIVE CAREFULLY
Come Back SOON

You are about to leave Decentraland

Do you recognize this domain?

themetasandwich.com

This scene is trying to redirect you to:

https://themetasandwich.com/order.php?Bread=B2&Meat=M6&Vegetable=V5_V2_V2&Condiment=C5&Additional=A1

Are you sure you want to continue?

CANCEL **CONTINUE**

Trust this domain

A grid of 14 items in a virtual inventory. The items include two slices of bread, a knife, two green herbs, a slice of orange, and a small sandwich icon.

21
CLICK TO DROP ITEM

SUBMIT YOUR METASANDWICH

YOUR INGREDIENTS:

*Wheat Bread - Turkey - Avocado Spread - Lettuce - Lettuce - Oil / Vinegar -
Chocolate Chip Cookie*



IF THE INTERNET VOTES YOURS AS THE WINNING JIMMY JOHN'S METASANDWICH,
IT WILL BECOME THE NEXT JIMMY JOHN'S REALSANDWICH.

FIRST NAME

PHONE NUMBER

NAME YOUR METASANDWICH

LAST NAME

EMAIL ADDRESS

METASANDWICH INSPIRATION

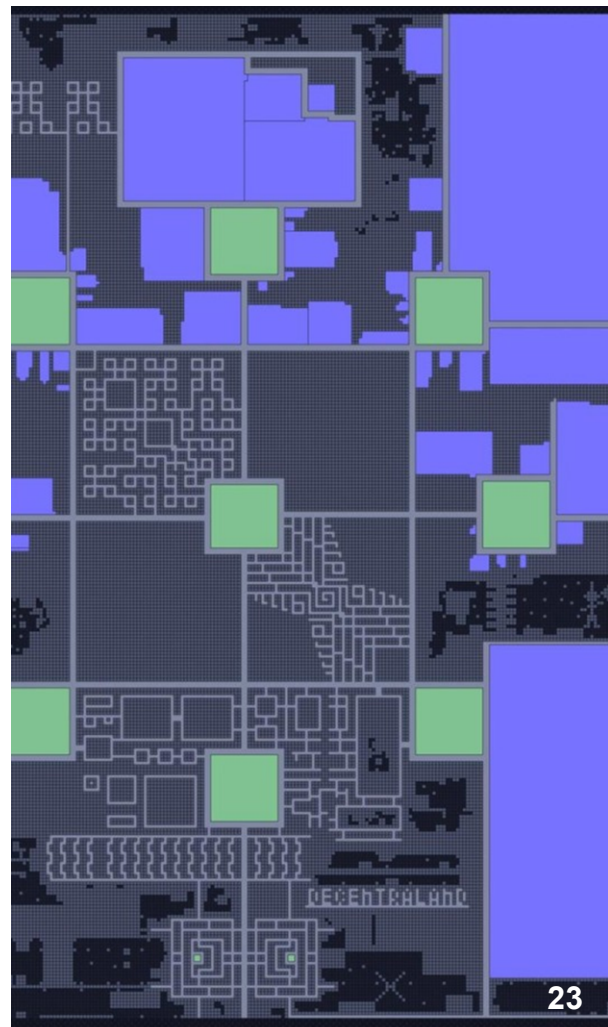

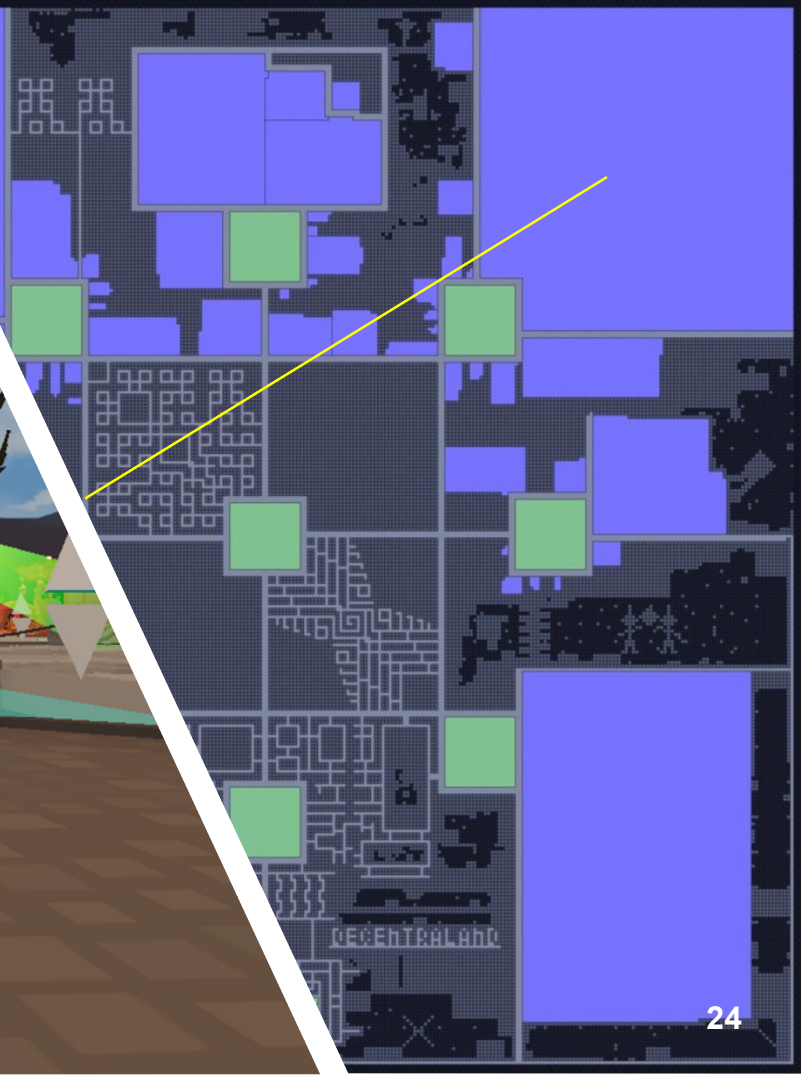

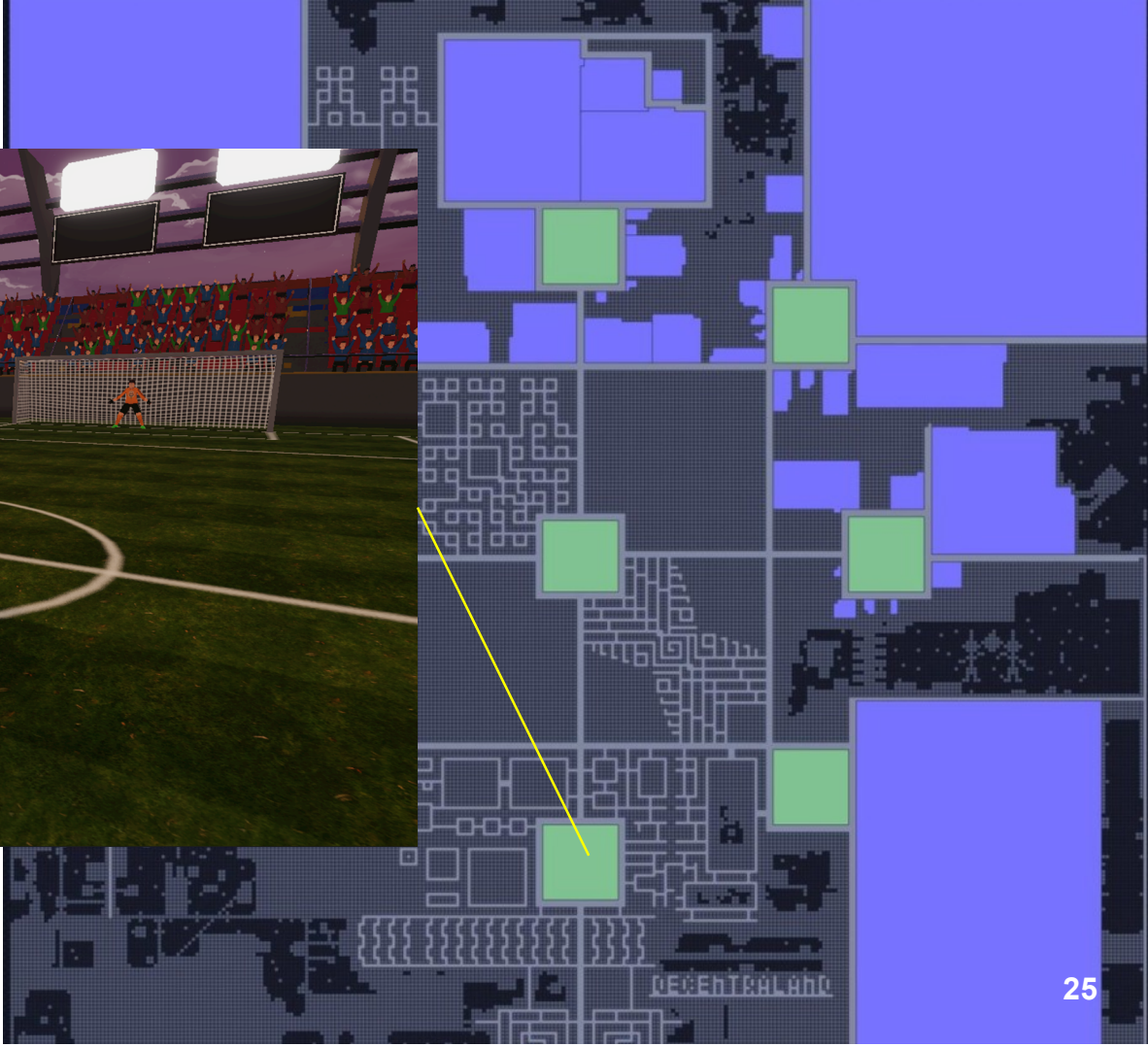

Morgan Lewis



Welcome to realm dg!

Type /help for info about controls

Jumped to [60.1!](#)

Jumped to [82.1!](#)

Jumped to [94.2!](#)

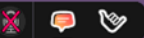

次食店

IBUTE



Black Oversized tweed jacket



controls

You are about to leave Decentraland

Do you recognize this domain?

dressx.com

This scene is trying to redirect you to:

<https://dressx.com/collections/faith-connexion/products/black-oversized-tweed-jacket>

Are you sure you want to continue?

CANCEL **CONTINUE**

Trust this domain

DRESSX / FAITH CONNEXION / BLACK OVERSIZED TWEED JACKET



Faith Connexion
Black Oversized tweed jacket

\$60.00 USD

+

UPLOAD PHOTO

Please upload your image(s) before adding to cart.
File size should be between 1 Mb and 100 Mb. If you file is more than 100 Mb, please use the field to add the link to the file after adding the product to cart.

Paste link here

Quantity - 1 +

ADD TO CART

BUY WITH Pay

More payment options

Crafted in black and white tweed, this oversized jacket is one of the essentials in the Faith Connexion collections and wardrobe.

THIS IS A DIGITAL ITEM. IT ONLY EXISTS DIGITALLY AND WILL BE APPLIED TO YOUR PHOTO(S).

Color: black.

Material: digital tweed.

Digital clothes fit all sizes.

About the brand:

With every new season, Faith Connexion goes back to its roots and reinterprets its guiding principles in a never-ending cycle of renewal. For Fall-Winter 2023, the collective unearthed the embodiment of a «too much is never enough» attitude straight out of the 2000s, the era that gave birth to the brand.

Against this stark backdrop, the pieces of the collection embody the soul and allow each participant to tell their story and establish their identity! Inspirations from different eras mix and merge as if passed through a filter. Pamela Anderson (Pam & Tommy era) as much as Paris Hilton, and yet would be perfectly at home in the wardrobe of Cassie from Season 2 of Euphoria.



Morgan Lewis





DRESSX Business Blazer - Dark Blue

\$30.00 USD



UPLOAD PHOTO

Please upload your image(s) before adding to cart.
File size should be between 1 Mb and 100 Mb. If you file is more than 100 Mb, please use the field to add the link to the file after adding the product to cart.

Paste link here

Quantity

-

1

+

ADD TO CART

BUY WITH  Pay

More payment options
How to wear DRESSX and Digital Fashion | [Ask us a question](#)

Need to ace your next job interview? Want to create a winning photo for your LinkedIn? Or come up with a cool corporate look to make your company stand out? DRESSX Business collection was made to streamline your business content creation, allowing you to generate impeccable formal looks in just a couple of clicks.

The DRESSX business blazer is available in 9 colorways, making sure you look just on point throughout the seasons, business occasions, time zones, countries, and Metaverses.

THIS IS A DIGITAL ITEM, IT ONLY EXISTS DIGITALLY AND WILL BE APPLIED TO YOUR PHOTO(S).

Material: 100% digital wool & silk.

Digital clothes fit all sizes.



Morgan Lewis





Everyone has a role in protecting the integrity of this space, so if you see these rules being violated by another Avatar, you can report it to Decentraland's Community.

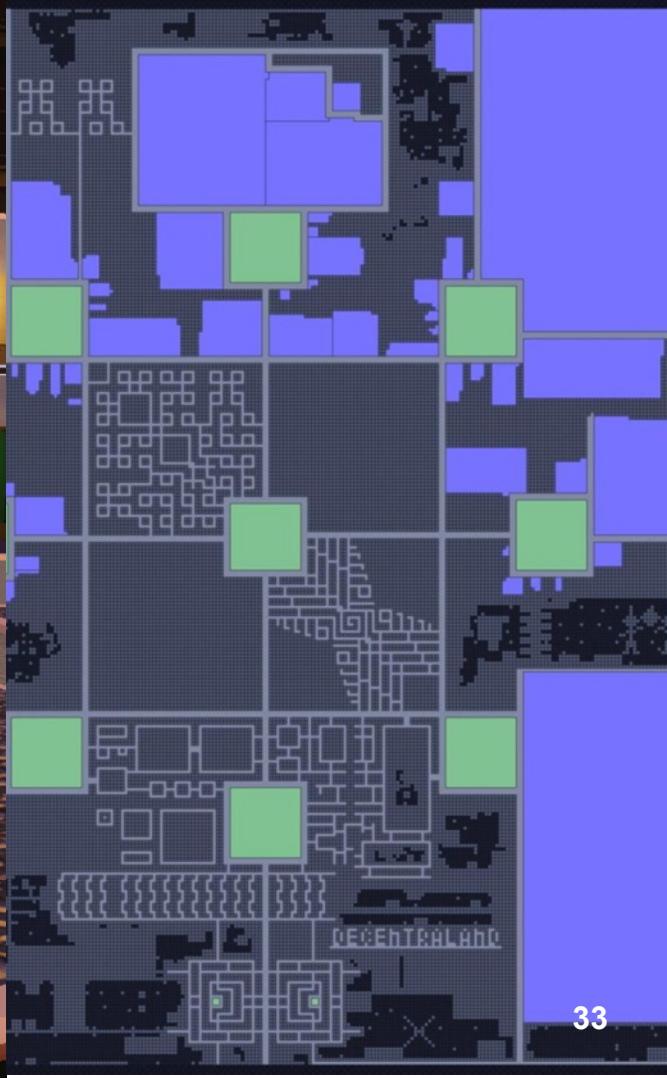



N



Samsung
837x

E

S

Samsung 837x
2,76



Welcome to realm athena!

type /help for info about controls

N

W E

Samsung
837x

S

Samsung 837x

103,79

IZATION
GE
Your way.

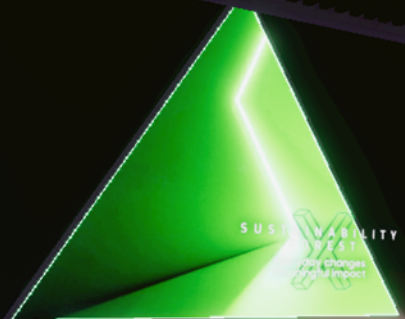

SAMSUNG
837X

Welcome to 837X

Sustainability Forest
Discover how Samsung is making everyday changes for a meaningful impact on our environment.

Connectivity Theater
Learn more about your favorite products and new releases, and tune in for live streamed workshops, unboxings and more.

Customization Stage
Come here for can't-miss concerts, special performances, giveaways and more.

Welcome to realm athenal!

Type /help for info about controls



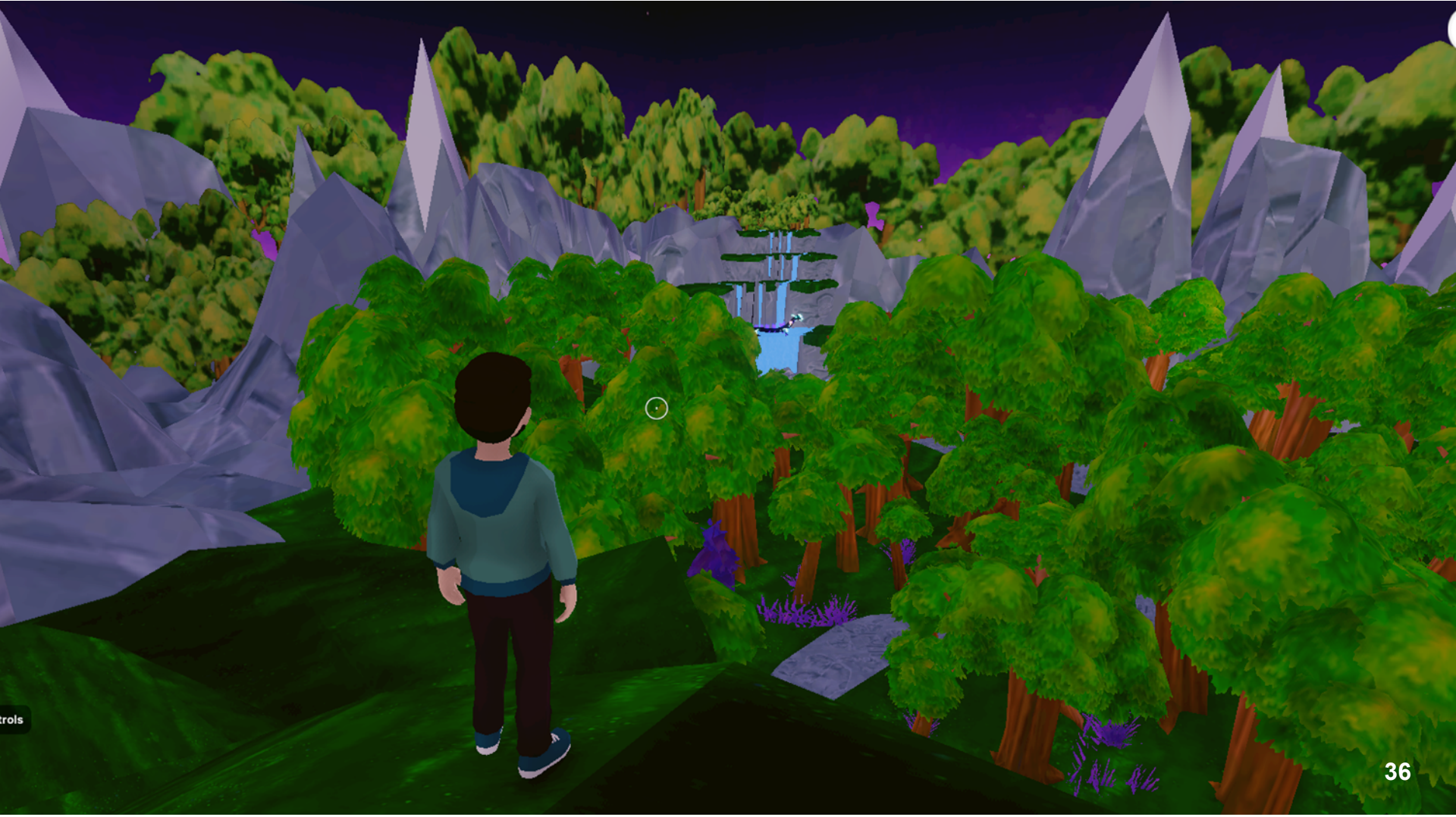

E

SAMSUNG
837%



Sustainable Materials

Phones, appliances, tablets and more that meet the EPA's highest.

Click to shop products made with sustainable materials



SAMSUNG
837%



Energy Efficiency

Our phones, home appliances, wearables and other products designed to be more energy efficient.

Click to shop energy efficient products



Click for more info!

ena!

out controls

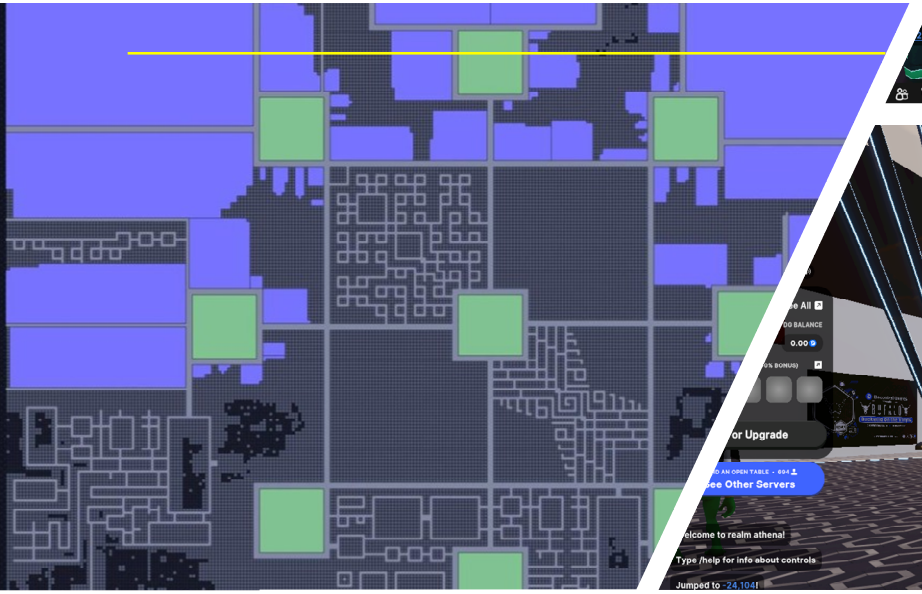

Crypto Valley Art (E)

The Crypto Valley

CRYPTO VALLEY

WELCOME

alm athena!

info about controls

104!

8,128!

0,135!

1,128!

.78!

18!

9b7b: this **** show...



Crypto Valley Art CEI

The Crypto Valley

82

100%

alm-athena

Info about controls

1941

9-1281

5-1351

1-1221

2-1

181

9b7b: this **** show...

CRYPTO VALLEY WELCOME

Morgan Lewis

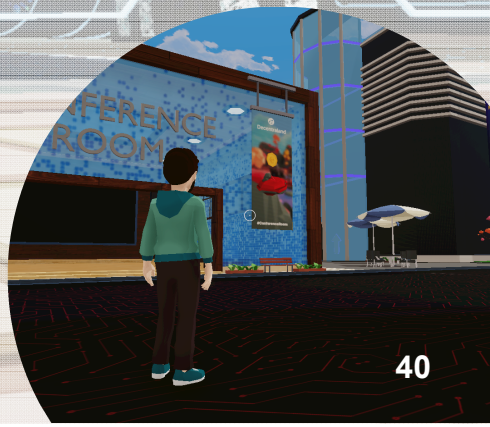

MSY
Gal

crypto Valley
Convention Cen
E

alm athena!

info about controls

,104!

8,128!

0,135!

1,128!

,76!

18!

9b7b: this **** show...

18!



City of Los Santos
N
The Crypto Valley
W E
The WallS
Nifty Passage
56, 15



EXCLUSIVE HANDMADE LEATHER SHOES WEARABLE IN THE METAVERSE, IN THE REAL-WORLD, AND TREDABLE AS NFTS

Swappable



TrustSwap

Another1 and Swappable joined forces with 23 industry leaders to create the world's first Italian "phygital" sneakers.

These limited-edition sneakers will be launched as an NFT collectible on the Polygon blockchain. Each sneaker will be randomly generated in a mystery sneaker box at the time of mint. The NFT will provide owners the right to request a physical pair IRL. To receive a physical asset, you must burn your NFT!

NTRI:META holders will automatically access a lottery for a chance to win 150 tickets to the AIBC Summit in Dubai on March 20-23, 2022!

The private sale goes live at 13:00 UTC on 16th March. The whitelist minting will begin at 09:00 UTC on 17th March. The main sale will begin at 13:00 UTC on 17th March.



 find out more and buy

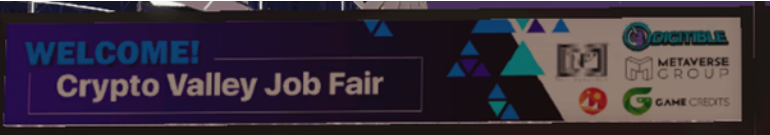
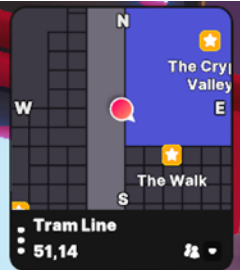

- Welcome to realm athenal
- Type /help for info about controls
- Jumped to [-24,104!](#)
- Jumped to [-138,128!](#)
- Jumped to [-120,135!](#)
- Jumped to [-101,128!](#)
- Jumped to [-70,76!](#)
- Jumped to [58,18!](#)
- JustFoldM8#9b7b: this **** show...
- Jumped to [66,18!](#)









 Follow us on Twitter!





MARKETPLACE

BUILDER

DOCS

EVENTS

DAO

BLOG

Land

Collectibles

My Store

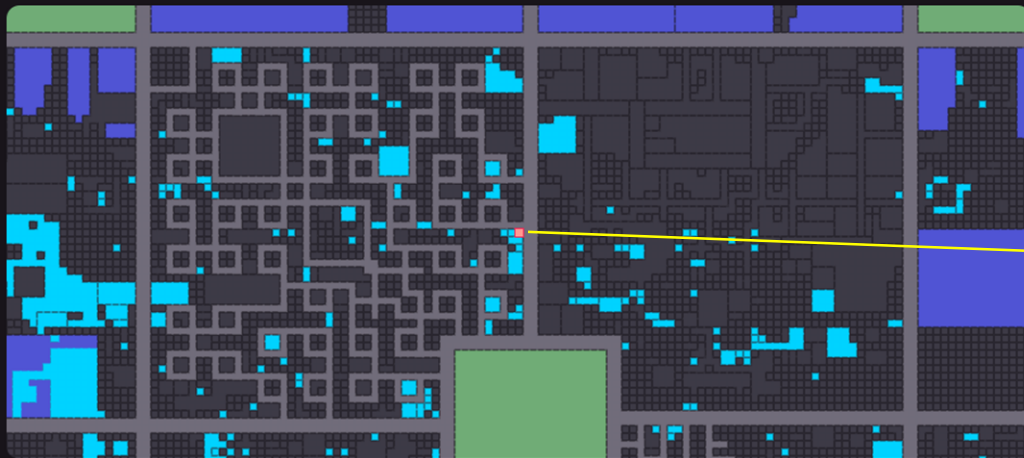

Parcel

📍 -1.25

JUMP IN ↻

OWNER



0xf952

PRICE

📍 200,000

NETWORK

Ethereum

BUY

Morgan Lewis





PRICE
200,000

NETWORK
Ethereum

BUY

coinbase

Prices Learn Individuals Businesses Developers Sign in Sign up

Decentraland to US Dollar

200000 MANA equals \$213,500.00 USD.

Buy MANA

200000 213500.00

MANA USD

Corporate Issues in the Metaverse



Morgan Lewis

What you should be considering?

- Choosing which metaverse to house your business.
- What are the community rules in the metaverse?
- Acquiring metaverse land.
- Ownership.
- How will the company make money?



Business Opportunities in the Metaverse?

- Higher education
- Virtual events
- Retail
- Enterprises
- Social media



List of Big Brands that Has Partnered with Sandbox

- The Smurfs
- Atari
- Snoop Dogg
- Adidas
- The Walking Dead
- OpenSea



Statistics Related to Sandbox

- \$13.8 billion fully diluted market cap for its SAND token (source: [CoinMarketCap](#))
- \$10,000 floor price for land (source: [OpenSea](#))
- \$1.45 billion in traded land value (source: Naavik)
- A return on investment of over 11,000% for the past year

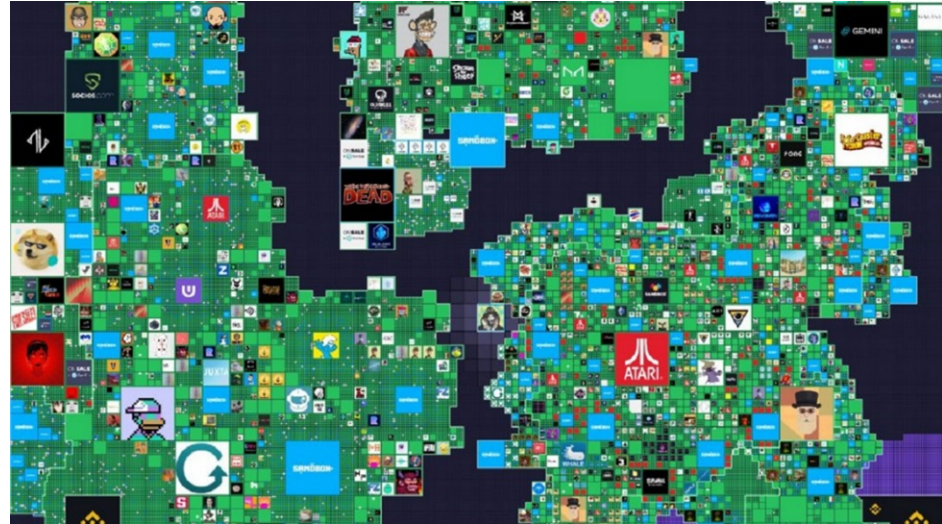

IP Issues in the Metaverse



Morgan Lewis

Metaverse IP Issues

- Trademarks
- Copyrights
- Patents
- Data protection and privacy



Metaverse IP Litigation - Trademarks

UNITED STATES DISTRICT COURT
SOUTHERN DISTRICT OF NEW YORK

-----x
HERMÈS INTERNATIONAL and HERMÈS OF
PARIS, INC.,
:
: Plaintiffs,
: 22-cv-384 (JSR)
: -v- : MEMORANDUM ORDER
: MASON ROTHSCHILD,
: :
: Defendant.
:-----x

JED S. RAKOFF, U.S.D.J.

Around December 2021, defendant Mason Rothschild created digital images of faux-fur-covered versions of the luxury Birkin handbags of plaintiffs Hermès International and Hermès of Paris, Inc. (collectively, "Hermès"). Rothschild titled these images "MetaBirkins" and sold them using so-called "NFTs" (non-fungible tokens), explained further below. In response, Hermès filed a complaint, subsequently amended, claiming trademark infringement, trademark dilution, and cybersquatting.

Now before the Court is Rothschild's motion to amend complaint for failure to state a claim upon which relief can be granted under Fed. R. Civ. P. 12(b)(6). ECF No. 49. The motion is fully briefed and the Court heard oral argument on 4/14/22. As the Court stated by "bottom-line" order on 4/14/22, see ECF No. 49, the Court denies the motion to dismiss. This

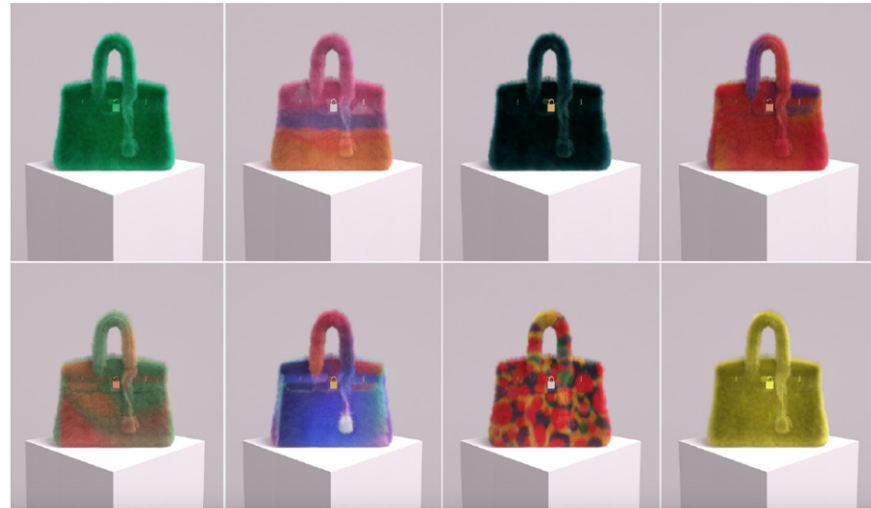

³ Rogers might not apply, Rothschild seems to concede, if the NFTs were attached to a digital file of a **virtually wearable Birkin handbag**, in which case the "MetaBirkins" mark would refer to a non-speech commercial product (albeit not one that is, as yet, considered ordinary or quotidian).

Hermes v. Rothschild

Metaverse IP Litigation - Trademarks

UNITED STATES DISTRICT COURT
FOR THE SOUTHERN DISTRICT OF NEW YORK

NIKE, INC.,
Plaintiff,
v.
STOCKX LLC,
Defendant.

Case No. 22-cv-993
COMPLAINT

Plaintiff Nike, Inc. ("Nike") ("StockX" or "Defendant") for the reasons stated herein, alleges as follows:

1. This lawsuit arises from Nike's famous marks in connection with its sale of Non-Fungible Tokens or "NFTs" on the blockchain. NFTs are commonly collected, sold, and traded in the metaverse by their consumers in and out of the

emerged throughout the past two years. Far more than a fleeting trend, NFTs are part of the future of commerce.

2. Unfortunately, novel product offerings, burgeoning technologies, and gold rush markets tend to create opportunities for third parties to capitalize on the goodwill of reputable brands and create confusion in the marketplace. NFTs are, not surprisingly, no exception to the rule, and this new frontier has swiftly become a virtual playground for infringers to usurp the



Nike, Inc. v. StockX LLC

Metaverse IP Litigation

- Copyrights
 - Nygard v. Whitely (Caked Apes)
 - Roc-A-Fella Records v Damon Dash
 - Miramax v. Quentin Tarantino



Metaverse Patents

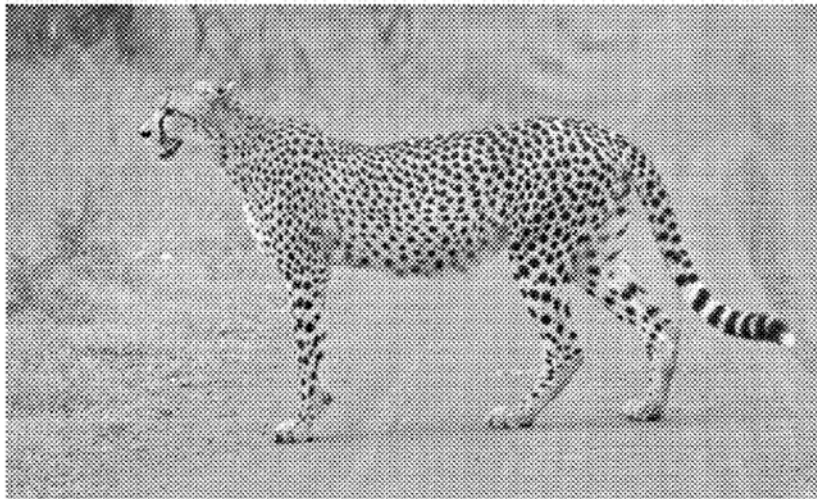

INPUT 2D IMAGE

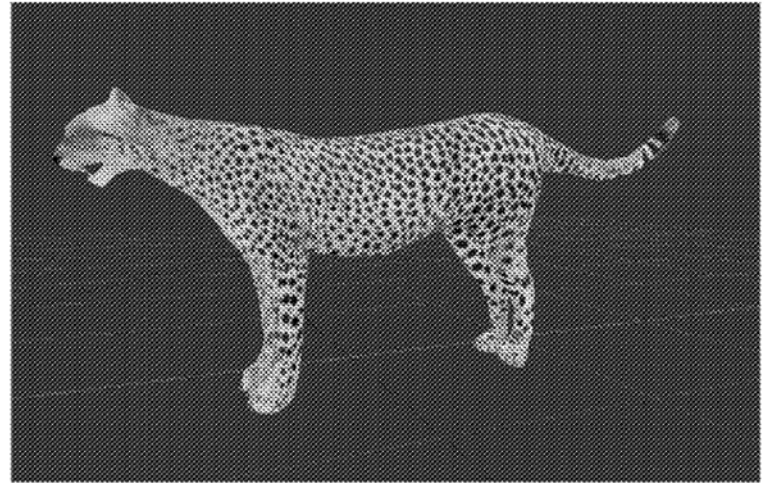

3D PRACTICAL ASSET

FIG. 6G

Metaverse Patents

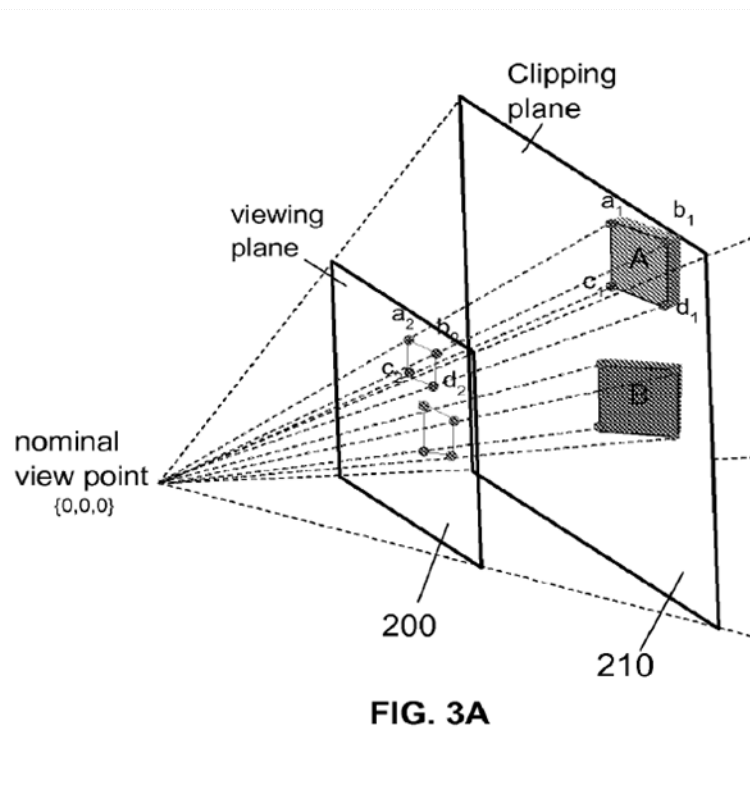

Morgan Lewis

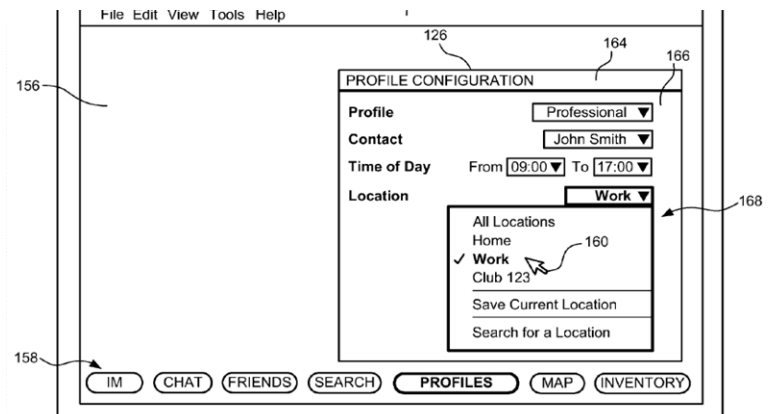
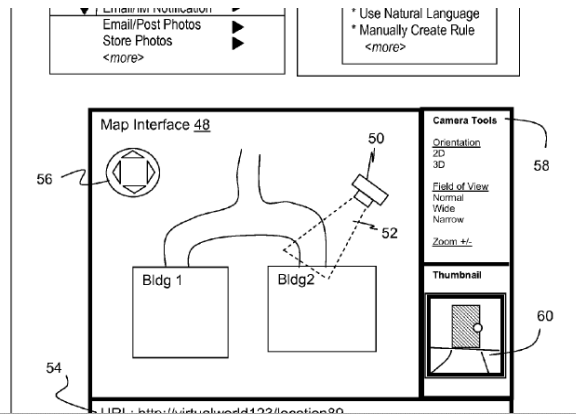

Metaverse Patents



How will litigation in the metaverse occur?



Regulation in the Metaverse?



Morgan Lewis

Metaverse is a virtual world with its own set of rules.

<https://abovethelaw.com/2022/04/what-laws-apply-in-metaverse>

Decentraland DAO



What is the Decentraland DAO?

DAO stands for "Decentralized Autonomous Organization". The Decentraland DAO owns the most important smart contracts and assets that make up Decentraland – the LAND Contract, the Estates Contract, Wearables, Content Servers and the Marketplace. It also owns a substantial purse of MANA which allows it to be truly autonomous as well as subsidize various operations and initiatives throughout Decentraland.

<https://dao.decentraland.org/en/>

Where do we see the metaverse headed in 5-10 years?

**Gartner Predicts 25% of
People Will Spend At Least
One Hour Per Day in the
Metaverse by 2026**

Takeaways - Stepping into the Metaverse

- Register IP assets
- Monitor and enforce IP
- Consider impact on current and future license agreements
- Dive in!
 - Many metaverses to choose from, but which one is right for me?
 - Digital asset acquisition

Technology Marathon 2022

Upcoming Metaverse-Related Programs

Date and Time	Program
Wednesday, June 8	
01:00 PM – 02:00 PM ET 12:00 PM – 01:00 PM CT 10:00 AM – 11:00 AM PT	<u>Patents in the Metaverse</u>
Thursday, June 9	
02:00 PM – 3:00 PM ET 01:00 PM – 02:00 PM CT 11:00 AM – 12:00 PM PT	<u>Trademark and Copyright Issues for NFTs and the Metaverse</u>
Tuesday, June 14	
01:00 PM – 02:00 PM ET 12:00 PM – 01:00 PM CT 10:00 AM – 11:00 AM PT	<u>Competition in the Virtual World</u>

Ukraine Conflict Resources

Our lawyers have long been trusted advisers to clients navigating the complex and quickly changing global framework of international sanctions. Because companies must closely monitor evolving government guidance to understand what changes need to be made to their global operations to maintain business continuity, we offer a centralized portal to share our insights and analyses.

Morgan Lewis

To help keep you on top of developments as they unfold, visit the website at www.morganlewis.com/topics/ukraine-conflict

To receive a daily digest of all updates, please visit the resource page to **subscribe** using the "Stay Up to Date" button.

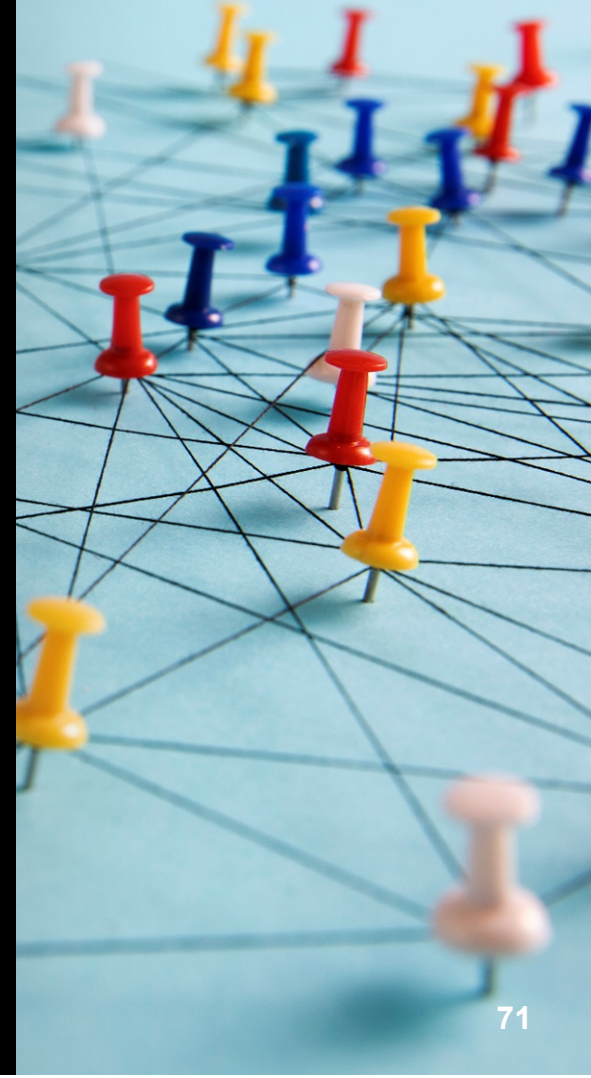

Biography



Dion M. Bregman

Partner

Silicon Valley, CA

+1.650.843.7519

dion.bregman@morganlewis.com

With decades of experience, Dion focuses on Patent Trial and Appeal Board (PTAB) trials, and patent prosecution, counseling, and litigation. He has led well over 100 PTAB trials. He also oversees large patent portfolios for Fortune 500 companies and startups alike. Dion is the deputy leader of the firm's intellectual property practice, leads the firm's PTAB team, is managing partner of the firm's Silicon Valley office, co-leads the firm's technology industry team, and leads the IP group's technology team. Dion was also named a "California Lawyer of the Year" by *California Lawyer*.

Biography



Jason E. Gittleman

Partner

Silicon Valley, CA

+1.650.843.7593

jason.gittleman@morganlewis.com

Morgan Lewis

Jason brings an electrical and computer engineering background to his services, which focus on patent litigation in the electrical and mechanical arts. Jason practices primarily before US District Courts and the US International Trade Commission (ITC), and he is also engaged in patent post grant proceedings before the Patent Trial and Appeal Board, patent portfolio analysis, infringement and invalidity analysis, and IP due diligence.

Jason spent three years in the Morgan Lewis Tokyo office where he assisted Japanese clients with US intellectual property matters, including patent litigation support. He also counseled US companies on Japan-related IP matters.

Prior to attending law school, Jason was a design engineer with a major New York engineering consulting firm, where he designed copper and fiber telecommunications systems. As a design engineer, he worked on the Phoenix Project, the name given to the reconstruction of the Pentagon after the September 11, 2001, attacks

Biography



Jeanette Kernizan Adelson

Law Clerk

New York, NY

+1.212.309.6029

jeanette.adelson@morganlewis.com

Jeanette is a law clerk in the corporate business transactions practice. Jeanette's practice concentrates on the representation of corporate and individual clients in the context of mergers and acquisitions involving both public and private companies, and corporate governance. While in law school, Jeanette participated in the Community Business Clinic to assist clients with complex corporate governance matters and formation. Jeanette also worked as a legal intern for various organizations, most notable, at a boutique law firm which advised clients in emerging business and venture capital and another boutique law firm which specialized in nonprofits and foundations. Also while in law school, Jeanette co-founded a nonprofit, Foundation of Freedom, an organization focused on economically empowering the Black community through financial literacy programs and small business support.

Our Global Reach

Africa
Asia Pacific
Europe
Latin America
Middle East
North America

Our Locations

Abu Dhabi
Almaty
Beijing*
Boston
Brussels
Century City
Chicago
Dallas
Dubai
Frankfurt
Hartford
Hong Kong*
Houston
London
Los Angeles
Miami
New York
Nur-Sultan
Orange County
Paris
Philadelphia
Pittsburgh
Princeton
San Francisco
Shanghai*
Silicon Valley
Singapore*
Tokyo
Washington, DC
Wilmington

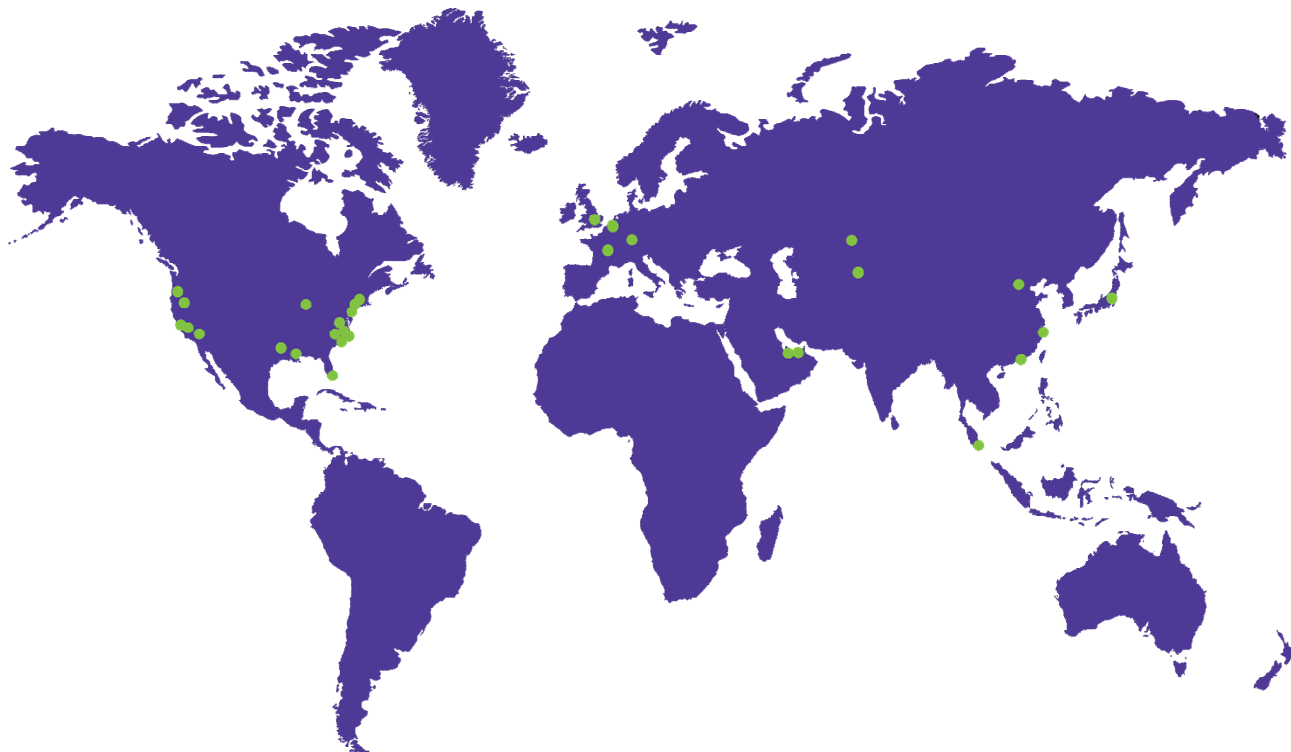

Morgan Lewis

Our Beijing and Shanghai offices operate as representative offices of Morgan, Lewis & Bockius LLP. In Hong Kong, Morgan, Lewis & Bockius is a separate Hong Kong general partnership registered with The Law Society of Hong Kong. Morgan Lewis Stamford LLC is a Singapore law corporation affiliated with Morgan, Lewis & Bockius LLP.

THANK YOU

© 2022 Morgan, Lewis & Bockius LLP
© 2022 Morgan Lewis Stamford LLC
© 2022 Morgan, Lewis & Bockius UK LLP

Morgan, Lewis & Bockius UK LLP is a limited liability partnership registered in England and Wales under number OC378797 and is a law firm authorised and regulated by the Solicitors Regulation Authority. The SRA authorisation number is 615176.

Our Beijing and Shanghai offices operate as representative offices of Morgan, Lewis & Bockius LLP. In Hong Kong, Morgan, Lewis & Bockius is a separate Hong Kong general partnership registered with The Law Society of Hong Kong. Morgan Lewis Stamford LLC is a Singapore law corporation affiliated with Morgan, Lewis & Bockius LLP.

This material is provided for your convenience and does not constitute legal advice or create an attorney-client relationship. Prior results do not guarantee similar outcomes. Attorney Advertising.